

Analyzing the Impact of Optical Wireless Communication Technologies on 5G/6G and IoT Solutions: Prospects, Developments, and Challenges

Ramsha Khalid^{1,2}, Muhammad Naqi Raza¹

¹ Department of Electrical Engineering Technology, University of Sialkot, Sialkot, 51310, Pakistan

² Department of Electrical Engineering, University of Lahore, Lahore, 53720, Pakistan

*Corresponding author: Ramsha Khalid, University of Sialkot, Sialkot, Pakistan Email: ramshakhalid2404@gmail.com

ABSTRACT: The imminent 5G and 6G communication systems are projected to exhibit substantial advancements in comparison to the current 4G communication system. Several critical and prevalent concerns pertaining to the service quality of 5G and 6G communication systems encompass elevated capacity, extensive connectivity, minimal latency, robust security measures, energy efficiency, superior quality of user experience, and dependable connectivity. Undoubtedly, 6G communication is expected to offer markedly improved performance across these domains compared to 5G communication. The integration of the Internet of Things (IoT) within the framework of the tactile internet is anticipated to be a fundamental component of advanced communication systems, encompassing both 5G and beyond (5GB), such as 5G and 6G. Consequently, 5GB wireless networks will encounter various challenges in accommodating diverse types of heterogeneous traffic and meeting the specified parameters related to service quality. Optical wireless communication (OWC), alongside various other wireless technologies, emerges as a promising candidate to fulfill the requisites of 5G communication systems. This comprehensive review articulates the efficacy of OWC technologies, including Visible Light Communication (VLC), Light Fidelity (LiFi), Optical Camera Communication (OCC), and Free Space Optics (FSO) Communication, as a viable solution for the successful deployment of 5G/6G and IoT systems.

KEYWORDS: 5G, 6G, internet of things, heterogeneous traffics, wireless technologies, communication systems, Optical Wireless Communication

1. Introduction

In recent times, OWC technologies have garnered significant research attention owing to their notable features [1–5]. OWC designates wireless connectivity utilizing the optical spectrum. OWC has positioned itself as a favored complementary technology to Radio Frequency (RF)-based wireless technologies, particularly in the context of future communication networks, encompassing the 5G and 6G communication systems. OWC technologies exhibit several notable features, including broad spectrum coverage, high data rates, minimal latency, robust security, cost-effectiveness, and energy efficiency. These attributes effectively cater to the demanding specifications of 5GB communications, exemplified by 5G and 6G technologies. In addition to this, the IoT network is gaining significant importance, with a proliferation of end-user devices or sensors being

interconnected within IoT. Furthermore, the integration of tactile internet will emerge as a pivotal aspect of future IoT, facilitating real-time communication systems across various societal, industrial, and commercial applications. In visualizing the concept of IoT, there is an exponential surge in the quantity of physical devices connected to the internet [6]. Hence, the IoT generates a substantial volume of data. OWC technologies assume a crucial role in sensing, monitoring, and facilitating resource sharing within the extensive device connectivity of IoT networks [2,6]. Additionally, OWC can effectively fulfill the low-power consumption and stringent security requisites of IoT.

The specifications for the 5G communication system have been finalized, and it is anticipated that 5G will be fully implemented by 2020 [7]. The forthcoming 5G communication infrastructure will introduce novel services characterized by exceptionally high Quality of

Service (QoS). Key attributes of 5G communication services will encompass unparalleled system capacity, minimal latency, enhanced security measures, extensive device connectivity, minimal energy consumption, and exceptional Quality of Experience (QoE) [7–11]. The introduction of the 6G communication system is projected to occur within the timeframe spanning 2027 to 2030. While the precise specifications for 6G have yet to be defined, numerous researchers are actively engaged in its development [12–16]. Research challenges encompassing capacity enhancement, augmented connectivities, latency reduction, heightened security, improved energy efficiency, elevated user QoE, and enhanced reliability are focal points addressed by both the 5G and prospective 6G communication systems. The forthcoming 6G communication infrastructure is anticipated to serve as a global communication cornerstone, offering service levels significantly superior to those of 5G.

RF currently serves as a prevalent choice for diverse wireless connectivity needs. However, RF-based wireless communication encounters significant hurdles, including spectrum limitations, susceptibility to interference, and stringent regulatory constraints. Sole reliance on RF technologies proves inadequate in meeting the demands of 5G and IoT networks. Consequently, researchers are diligently exploring alternative spectrums to address the escalating requirements. One particularly promising avenue involves leveraging a significantly expansive optical band. This strategic shift toward OWC holds considerable potential for advancing 5G and IoT networks, offering distinct advantages over conventional RF-based networks. These advantages encompass heightened data rates, diminished latency, enhanced security, and improved energy efficiency [1–3], [6]. Effective communication spans distances ranging from a few nanometers to over 10,000 kilometers, facilitated by the implementation of various OWC systems [2]. Key technologies integral to OWC networks comprise VLC [6][17–19], LiFi [20–22], OCC [23–27], and FSO [28–30]. A subsequent section provides a concise exploration of the distinctions and commonalities inherent in these technologies. Each of these technologies possesses unique strengths alongside certain limitations. Diverse OWC technologies present a spectrum of services catering to indoor, outdoor, and space communications. Consequently, OWC technologies assume a crucial role in realizing the objectives of 5G and IoT systems.

Our prior review paper concerning OWC [2] extensively examines and compares various optical wireless technologies, offering a comprehensive understanding of their distinctions. However, the primary objective of the current review paper diverges from providing a detailed explanation of OWC technologies. Instead, its focus is on illustrating how

OWC technologies can serve as an effective solution for the seamless deployment of 5G/6G and IoT systems. Within this study, we delineate potential detailed solutions for 5G/6G and IoT utilizing diverse OWC networks. This paper's contributions can be succinctly outlined as follows:

1. Comprehensive examination of the key characteristics of 5G and IoT networks, with a brief presentation of potential 6G requirements.
2. Concise discussion of various OWC technologies within the context of 5G/6G and IoT systems.
3. Detailed exploration of the scope of OWC technologies in meeting the specific requirements of 5G/6G and IoT deployments.
4. Thorough survey of recent advancements in OWC technologies pertaining to 5G and IoT solutions, accompanied by a discussion on emerging research trends.
5. In-depth consideration of challenging issues associated with the deployment of OWC for 5G/6G and IoT solutions.

The subsequent sections of the paper are structured as follows: Section 2 furnishes a concise overview of the requirements associated with 5G, 6G, and IoT. Section 3 provides an in-depth description of various OWC technologies. In Section 4, the potential of OWC technologies to address the demands of 5G, 6G, and IoT systems is elucidated. Section 5 delves into several key challenging issues inherent in OWC-based 5G/6G and IoT solutions. Finally, Section 6 encapsulates the conclusion of this paper.

2. Concise Examination of the Requirements for 5G, 6G, and IoT

5G is anticipated to deliver a significant enhancement in key attributes compared to 4G, enabling efficient support for the burgeoning array of heterogeneous multimedia applications with varying requirements [11]. The specifications for 5G requirements have been delineated, with full deployment of the 5G system anticipated by 2020. The essential requirements of 5G can be succinctly summarized as follows:

- *High Traffic Volume:* The mobile data volume per unit area is projected to increase by a factor of 1000 in comparison to 4G wireless networks, accompanied by a surge in the number of connected wireless devices, which is expected to be 100 times higher.
- *Massive Connectivity:* 5G is designed to facilitate massive connectivity, with the capability to connect ten to 100 times more devices than the 4G communication system [11].

- *High User Data Rate Link:* The 5G networks are mandated to support exceptionally high user data rates, enabling users to achieve up to 10 Gbps, representing a ten to 100-fold increase compared to 4G.
- *Low-Energy Consumption:* Significantly reduced energy consumption is a pivotal requirement in the 5G communication system, aiming to achieve more than a 90% reduction, i.e., 10 times lower compared to 4G networks [11].
- *Extremely Low Latency:* Ensuring extremely low latency, with end-to-end latency levels ranging from sub-millisecond to a few milliseconds, is a critical objective for 5G networks [11].

Researchers are currently engaged in the standardization of requirements for 6G networks [12–16,31–34]. A pivotal requirement for 6G is anticipated to be ultra-high bit rates per device, ranging from tens of gigabits per second to terabits per second [12,31]. Furthermore, 6G is projected to exhibit 1000 times higher simultaneous wireless connectivity compared to 5G. Envisaged characteristics for 6G encompass ultra-long-range communication coupled with ultra-low-power consumption, ensuring user experiences with latency of less than 1 millisecond [13]. Other key anticipated features of 6G include spatial multiplexing, higher spectral efficiency at 100 bits per second per Hertz, ultra-high wireless security, exceptional reliability, ultra-low-power consumption, and the integration of massively connected complex networks.

The networks will possess distinct characteristics designed to accommodate the demands of 5G wireless communication systems. The essential features of future 5G and 6G networks can be encapsulated as follows:

- *Ultra-High-Density Network:* To ensure consistent QoE, accommodate massive connectivity, and meet high capacity demands, 5G networks are anticipated to exhibit significantly higher density, characterized by ultra-dense heterogeneous networks, compared to their 4G counterparts.
- *Small-Cell Networks:* The establishment of high-density small-cell networks is identified as a fundamental characteristic in the design of 5G communication systems.
- *Higher Spectral Efficiency:* 5G systems are poised to optimize frequency spectrum utilization through the incorporation of multiple-input and multiple-output techniques, advanced coding and modulation schemes, and innovative waveform design. The targeted spectral efficiency for 5G is set to be at least three times higher than that of 4G networks.

- *Low Cost:* A key objective for 5G systems is to achieve a 100-fold increase in efficiency compared to 4G systems, delivering a hundred times more data traffic using the same energy across the network. This necessitates the adoption of low-cost network equipment, reduced deployment expenses, and enhanced power-saving functionalities on both network and user equipment sides [35].
- *Offloading Heavy Traffic to Indoors:* Recognizing that nearly 80% of mobile traffic is generated indoors, a strategic characteristic of 5G and 6G networks involves offloading this substantial data volume to indoor small cells. This approach aims to alleviate the strain on macrocells, preserving valuable resources and enhancing overall network efficiency [36].

3. Brief Overview of OWC Technologies

The four primary OWC technologies, namely VLC, LiFi, OCC, and FSO, are regarded as promising solutions to address the requirements of 5G/6G and IoT networks due to their unique features. Figure 1 provides a concise depiction of the architectures of these technologies [37]. In terms of infrastructure, these technologies exhibit variations in transmitter types, receiver configurations, and communication media. VLC utilizes light-emitting diodes (LEDs) or laser diodes (LDs) as transmitters and photodetectors (PDs) as receivers, utilizing only visible light (VL) as the communication medium. LiFi, akin to Wireless Fidelity (WiFi) technology, offers high-speed wireless connectivity alongside illumination, employing LEDs or diffuse LDs as transmitters and PDs as receivers. While VL serves as the forward path medium, LiFi employs infrared (IR) for the return path communication, although VL can also be utilized for the return path. However, the uplink communication performance in both VLC and LiFi may be constrained as receiver devices in most user equipment, such as smartphones, are not equipped with high-power LEDs [38–40]. Furthermore, they exhibit limitations in return path performance when the uplink involves diffused light, facing significant interference from the downlink lights. OCC employs an LED array or light as a transmitter, with a camera or image sensor serving as the receiver. The inclusion of built-in complementary metal-oxide semiconductor cameras enhances the capability to capture photos and videos [41]. The camera can be of either global shutter or rolling shutter type [42]. OCC typically utilizes VL or IR as the communication medium, although the ultraviolet (UV) spectrum can also be employed. FSO technology commonly employs a LD and PD as the transmitter and receiver, respectively. However, heterodyne optical detection receivers are also utilized in FSO communication. Typically, it operates using IR as the communication medium but can also utilize VL and UV. Table 1 outlines a comparison of performance metrics

across various OWC technologies [37]. These technologies exhibit distinct differences, with each offering specific characteristics. Notably, VLC distinguishes itself by employing visible light as its communication medium. A LiFi system is required to support seamless mobility, bidirectional communication, point-to-multipoint, and multipoint-to-point communications. Among all OWC technologies, only the OCC system utilizes a camera or image sensor as a receiver. Leveraging the narrow beams of focused light from a LD transmitter, FSO systems can establish both long-distance and high-data-rate communication links. For further insight into the variances among OWC technologies, refer to our previous work [2].

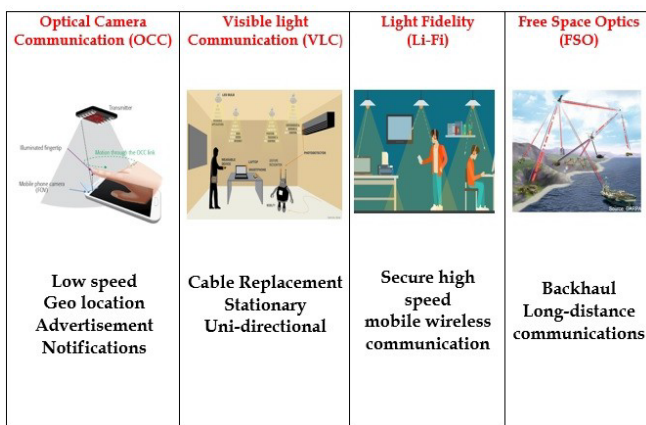

Figure 1: Taxonomies of OWC for 5G, 6G, and Internet of Underwater Things Communications.

4. OWC Technologies for the 5G, 6G, and IoT Solutions

4.1. Advantages of Opting for OWC Technologies

The RF band spans from 3 kHz to 300 GHz within the electromagnetic spectrum [2]. However, the range of 3 kHz to 10 GHz is predominantly utilized by existing wireless technologies due to its favorable communication properties. This spectrum is nearing exhaustion and falls short in meeting the high demands of 5G/6G and IoT networks. Additionally, it is subject to stringent regulations imposed by local and international authorities.

OWC emerges as a compelling alternative, offering outstanding features to address these stringent requirements. OWC finds application across a diverse range of scenarios, including machine-to-machine, device-to-device, chip-to-chip, vehicle-to-vehicle, vehicle-to-infrastructure, infrastructure-to-vehicle, point-to-point, and point-to-multipoint communications [2,6,29]. The inherent properties of light enable connectivity across a wide range, spanning from nanometers to over 10,000 km. This facilitates various communication scenarios, such as ultra-short-range inter-chip interconnects using FSO systems and in-body networks employing VLC, OCC, or LiFi systems. Other applications encompass short-range LiFi, vehicle-to-everything (V2X) communications, indoor positioning, medium-range inter-building networks, long-range inter-city backhaul connectivity, and extended-range satellite-to-satellite communications.

Furthermore, OWC technologies offer the capability to establish high-data-rate communication links. Key features of OWC encompass a wide unregulated bandwidth, enhanced security measures, low power consumption, cost-effectiveness in infrastructure and device deployment, absence of interference with RF devices and networks, high Signal-to-Noise Ratio (SNR), and seamless integration into existing lighting infrastructures. However, a notable limitation of OWC systems is the susceptibility to transmission blockage by obstacles.

The coexistence of RF and OWC networks presents an effective strategy for mitigating the limitations inherent in individual RF-based and optical wireless communication systems. Figure 2 showcases several notable 5G/6G and IoT platforms leveraging OWC technologies [37]. OWC networks have the capacity to support a myriad of applications across various aspects of daily life, including V2X communications, underwater communications, cellular connectivity support, space communication, smart shopping, eHealth, and smart home systems. This section elucidates how OWC networks can deliver effective solutions for the deployment of 5G, 6G, and IoT networks.

Table 1: Performance Metric Comparison Across Different Optical Wireless Communication Technologies [2,18,20,24,28,43]

Problem	Parameter	VLC	Lifi	OCC	FSO
Topology of communication	Direction	Uni or Bi-direction	Bi-direction	Uni-direction	Uni or Bidirection
Area of Communication	Distance	20m	10m	60m	10,000km
Deployment	support for mobility	Not- compulsory	compulsory	Not- Compulsory	No
Effect on environment	Indoor/ Outdoor	No/Yes	No/Yes	No	Yes
Obstruction	Level of Interference	Low	Lows	Zero	Low
Speed of communication	Data rate	100Gbps using LD and 10Gbps using LED	100Gbps using LD and 10Gbps using LED	55Mbps	40Gbps
Network Performance	Security (related to data encryption and protection measures)	High	High	High	High

4.2. Achieving Service Quality Characteristics

Substantial Capacity Enhancement: Achieving thousand-fold capacity improvements in 5G networks necessitates a significantly broader bandwidth, a requirement readily met by the optical spectrum. Table 2 provides a comparison of RF and optical frequencies within the electromagnetic spectrum [44]. The RF band occupies merely 300 GHz of this vast spectrum, while the optical band (ranging from 300 GHz to 30 PHz) offers considerably greater potential. Currently, only a fraction of the optical spectrum, encompassing parts of visible light, near-infrared, and middle ultraviolet, is actively utilized. However, ongoing research aims to expand utilization across the optical spectrum and enhance its efficiency. Notably, the terahertz band (0.3–3 THz) within the infrared region is anticipated to play a crucial role in future high-data-rate cellular communications [31]. Leveraging the expansive optical spectrum through various OWC technologies presents an opportunity to accommodate the substantial data capacity requirements. Additionally, high-speed network connectivity is imperative to support the extensive connectivity demands of massive IoT deployments. Thus, the optical spectrum holds promise in handling the substantial data traffic generated by high-data-rate heterogeneous multimedia applications in 5G, 6G, and IoT networks.

rate of 100 Gbps [18,45]. FSO technology also excels in supporting high-data-rate services both indoors and outdoors, facilitating outdoor remote high-speed connectivity. Additionally, OWC utilizing the UV band extends its capabilities to offer high-data-rate, non-line-of-sight communications [4]. Ongoing research initiatives aim to further elevate data rates within OWC technologies. Consequently, OWC technologies emerge as valuable complementary solutions for enabling high-data-rate connectivity in 5G, 6G, and advanced communication systems. As illustrated in Figure 3, a diverse array of OWC technologies facilitates high-speed connectivity scenarios for both indoor and outdoor users, as well as in V2X communications, offering promising prospects for supporting advanced communication systems beyond 5G and 6G [44].

Table 2: Comparison of RF and optical spectra [2–6,21,29]

Property	RF Spectrum	Optical Spectrum
Frequency Range	Limited (3 kHz to 300 GHz)	Extensive (300 GHz to 30 PHz)
Bandwidth	Restricted	Broad
Utilized Spectrum	Primarily below 300 GHz	A small portion (Visible light, near-infrared, middle ultraviolet) actively used
Future Research	Limited expansion potential	Ongoing research to explore and expand utilization
Emerging Band	Terahertz band (0.3–3 THz) within infrared	Potential for high-data-rate cellular communications in terahertz range [31]
Communication Medium	Radio waves	Light waves
Interference Potential	Susceptible to interference due to crowded spectrum	Lower interference potential as optical spectrum is underutilized
Capacity Potential	Limited capacity due to spectrum congestion	High capacity potential due to broad spectrum availability

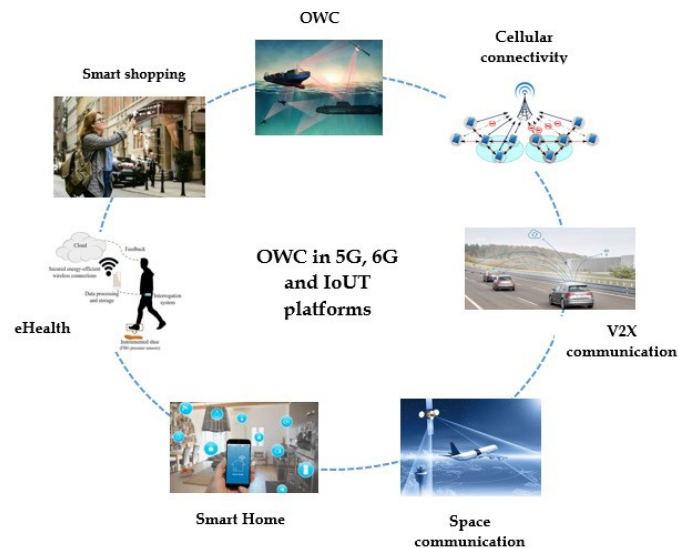

Figure 2: OWC networks for the 5G/6G and IoT platforms.

Ultra-High User Data Rate: The anticipated transmission rates for 5G mobile communication systems are projected to average around 1 Gbps, with a peak rate of 10 Gbps [8]. Subsequently, 6G is expected to support even higher bit rates ranging from tens of Gbps to Tbps per device. Notably, VLC and LiFi technologies demonstrate the capability to deliver exceptionally high-data-rate services at the user level. LiFi, in particular, offers comprehensive network support, encompassing point-to-multipoint, multipoint-to-point, and bidirectional communications akin to WiFi. VLC has already achieved a confirmed data

Ultra-low latency: Achieving low latency is a critical requirement for communication systems, especially in the context of 5G and beyond. OWC systems typically operate along line-of-sight (LOS) paths, resulting in minimal communication distance and no signal loss due to obstructions. In contrast, RF-based communications utilize both LOS and non-line-of-sight (NLOS) paths, encountering significant signal loss in NLOS scenarios and increased communication distances. Despite both optical and RF signals propagating at the speed of light, optical communication systems demonstrate faster communication due to rapid propagation. Furthermore, optical systems exhibit short processing times, enabling the provision of communication services with a fraction

of millisecond end-to-end delays. Consequently, OWC technologies emerge as a promising solution for 5G communication systems, delivering services with negligible latency.

Ultra-low-energy consumption: Energy efficiency stands out as a paramount requirement in the design of 5G, 6G, and IoT systems. OWC systems, predominantly structured around LEDs, align with this imperative. Currently deployed LEDs exhibit minimal power consumption, and ongoing global research endeavors are focused on further reducing their energy usage. Notably, LEDs serve a dual purpose by functioning as both illumination sources and communication transmitters, eliminating additional energy consumption when utilized for illumination. In comparison to RF sensors, LED sensors demonstrate significantly lower energy consumption. Consequently, OWC technologies present a compelling solution, offering communication systems with markedly low power consumption. This aligns seamlessly with the critical demand for energy-efficient communication systems in the deployment of 5G and IoT technologies.

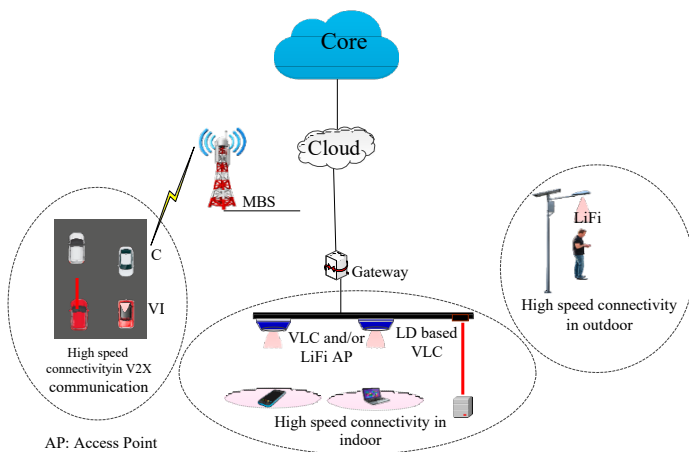

Figure 3: Achieving high-speed connectivity through various OWC technologies.

Reliable connectivity: Ensuring dependable connectivity stands as a pivotal criterion for any communication system. OWC systems offer a notably elevated SNR, particularly beneficial for indoor users. In outdoor scenarios, OCC ensures interference-free communication and a robust SNR, maintaining stable performance even with increased communication distances. FSO also exhibits commendable SNR levels for long-distance outdoor communication. Furthermore, OWC networks present an additional tier for indoor users, contributing to heightened communication system reliability. Consequently, OWC systems play a crucial role in enhancing connectivity reliability for users within the realms of 5G/6G and IoT networks.

Ultra-high security: OWC technologies, essential for the robust communication demanded by 5G, 6G, and IoT networks, ensure a high level of security. Due to the inability of OWC signals to penetrate obstacles, external

entities are prevented from unauthorized access to sensitive information. The impervious nature of OWC technology prevents external network hacking devices from intercepting internal optical signals. This unparalleled security feature makes OWC systems particularly well-suited for the exchange of information in highly sensitive domains, such as healthcare. Consequently, OWC systems provide an elevated level of security for 5G/6G and IoT networks.

4.3. Fulfilling the Network and Infrastructure Characteristics

Network densification using highly dense heterogeneous networks: Network capacity enhancement can be achieved through three primary methods: network densification, spectrum efficiency optimization, and utilization of additional frequency spectra. Network densification involves the strategic addition of more cell sites to augment capacity, encompassing the deployment of small cells and the optimization of frequency utilization. This approach strategically places cell sites in capacity-constrained areas to augment overall capacity and alleviate traffic congestion on surrounding sites. Network densification is particularly relevant in densely populated areas with significant traffic volumes. The 5G/6G communication systems, characterized by high system capacity and per-user data rates, necessitate the densification of access networks and the deployment of supplementary network infrastructures. Increasing the number of small cells can boost traffic volume, while reducing the access network-to-user distance enhances achievable data rates. Consequently, network densification, specifically through the deployment of small cells, becomes imperative to fulfill the demands of 5G/6G paradigms. In dense deployments, a combination of macrocells, wide-area networks, and various indoor and outdoor optical or RF small cells is employed. Each indoor environment may host multiple optical small cells (e.g., VLC, LiFi, and OCC networks) alongside RF small cells. Outdoor applications, such as vehicular networks and street lighting, also utilize numerous optical small cells for communication. The dense deployment of OWC networks aligns with the network densification criterion, ensuring a high-capacity FSO backhaul connectivity. Figure 4 illustrates that the OWC-based small-cell networks, in conjunction with RF small cells, contribute to a highly dense network deployment.

Multi-tier architecture and convergence of heterogeneous networks: To address the evolving requirements of future communication, networks will leverage a multi-tier architecture comprising broader coverage satellite and/or macrocell networks supporting smaller cells housing RF small cells alongside optical VLC, LiFi, and OCC networks. In this architecture, VLC and LiFi technologies form a sub-tier below RF small cells. Illustrated in Figure 4 is an exemplary depiction of this multi-tier architecture

featuring macrocells, RF small cells, and optical small cells. The integration of optical small cells, including VLC and LiFi, presents an opportunity to augment high-capacity capabilities within multi-tier wireless heterogeneous networks. Consequently, the burden on costly satellite or macrocell networks can be alleviated through load offloading to small-cell networks. Indoor OWC systems can efficiently serve a significant number of users, enhancing the overall service quality provided by outdoor macrocell and satellite networks, which are often constrained by capacity limitations. Furthermore, the incorporation of OWC technologies within multi-tier heterogeneous networks addresses the limitations inherent in RF-based wireless communication systems. Optical and RF signals operate independently, mitigating interference effects within the multi-tier network infrastructure. In essence, OWC technologies will assume a pivotal role in the advancement of multi-tier heterogeneous networks, spanning across 5G, 6G, and future generations of communication systems.

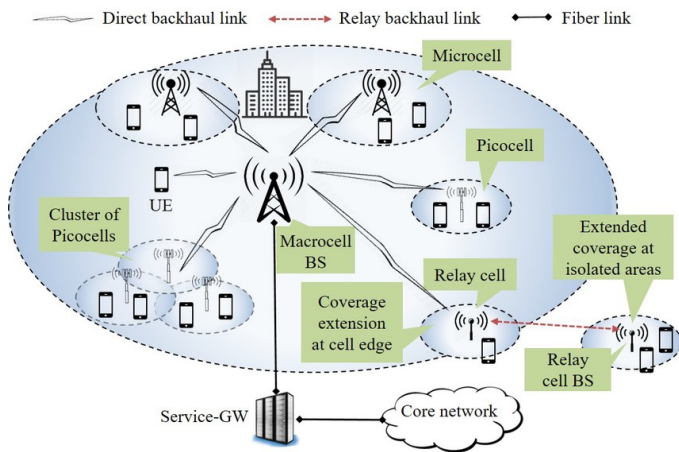

Figure 4: Scenario of heterogeneous multi-tier networks containing an RF microcell, many RF smallcells, and a large number of optical small cells.

Provision of hybrid network connectivity: Each of the distinct RF and optical wireless technologies possesses inherent limitations and advantages. The integration of heterogeneous networks, characterized by the coexistence of both RF and OWC technologies, offers an effective solution to overcome these limitations. The concurrent operation of two systems enhances link reliability and facilitates load balancing, thereby optimizing network performance. In outdoor applications, the hybrid system proves particularly advantageous in mitigating atmospheric effects. Figure 5 provides Performance Analysis of Hybrid Radio Frequency and Free Space Optical Communication Networks with Cooperative Spectrum Sharing. Collaboration between RF and optical links is leveraged to establish direct or relay-based connectivity from a source to a destination. The relay system incorporates optical links, connecting either from source-to-relay or relay-to-destination within the hybrid framework. Additionally, the simultaneous utilization of optical and RF links is possible in either or both of these

connection scenarios. The configuration of forward and return communication links may vary based on application scenarios and the specific hybrid architecture. This can involve separate forward and return paths or the sharing of paths, where optical links handle the forward path, and RF links manage the return path. Consequently, OWC technologies assume a pivotal role in the strategic design of hybrid systems, effectively mitigating limitations and providing viable solutions within the context of 5G/6G networks.

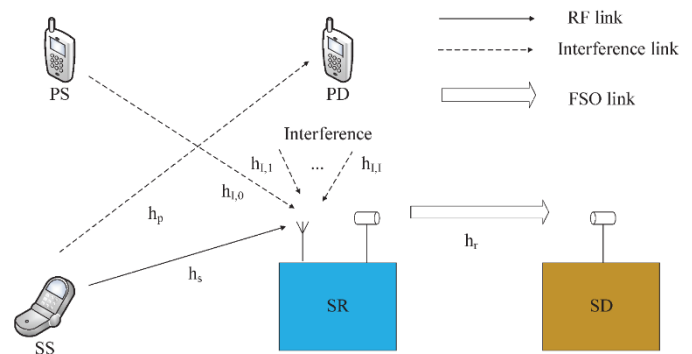

Figure 5: Performance Analysis of Hybrid Radio Frequency and Free Space Optical Communication Networks with Cooperative Spectrum Sharing

Massive device connectivity: Robust connectivity on a large scale stands as a pivotal attribute in the landscape of future communication systems. In the 5G era, the IoT is anticipated to interconnect a diverse array of up to 50 billion heterogeneous devices. This connectivity extends beyond mobile phones, encompassing applications in vehicles, household electronics, and medical equipment, contributing to the realization of a smart society [46]. The IoT, facilitated by massive connectivity, enables the integration of various sensors and physical devices, allowing them to communicate and interact autonomously, free from human intervention [47]. Projections for the 6G paradigm indicate an even broader scope, connecting a greater number of intelligent devices. OWC emerges as a pivotal enabler for achieving massive connectivity. The escalating use of LEDs is noteworthy due to their cost-effectiveness, low energy consumption, and extended lifespan. OCC, in particular, garners significant interest within the realm of IoT. Leveraging existing or minimally modified infrastructures, OCC presents economically viable solutions for a diverse range of IoT applications. Thus, OWC technology, employing low-power LEDs, has the potential to establish an extensive network of connections, aligning with the objectives of 5G/6G and IoT networks. Figure 6 illustrates various examples of widespread connectivity across different environments through diverse OWC technologies, supporting applications in homes, healthcare, transportation systems, remote connectivity, and smart grid systems [44]. In the context of smart grids, which integrate operational and energy-measuring devices like smart meters, appliances, renewable energy resources, and energy-efficient

technologies, OWC technologies facilitate extensive connectivity. Through these interconnected elements, smart grids serve as foundational components for effective energy management within a sustainable environment [47].

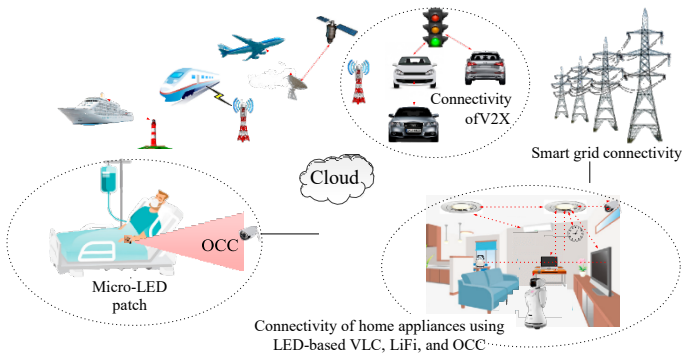

Figure 6: Several instances exemplify extensive connectivity facilitated by OWC technologies.

The IoT networks are characterized by several crucial requirements, including low device cost, low power consumption, economical deployment, heightened energy efficiency, robust security and privacy measures, and the ability to accommodate a large number of devices. LED-based OWC systems encompass all the essential features necessary to support the diverse needs of the IoT. Presently, key technologies employed for IoT connectivity include Zigbee, Bluetooth Low Energy (BLE), and WiFi. Zigbee, recognized for its cost-effectiveness and low-power attributes, serves as a prevalent wireless mesh network standard for IoT applications [48]. However, Zigbee faces limitations in terms of transmission rates and security levels, with interference emerging as a concern in densely populated Zigbee networks. BLE, designed as a low-energy variant of Bluetooth for short-range communication, operates in a single-hop topology (piconet) where one master device communicates with several slave nodes, alongside a broadcast group topology featuring an advertiser node broadcasting to multiple scanners [48]. On the other hand, WiFi lacks guaranteed QoS and is susceptible to interference due to shared unlicensed bands with Zigbee, Bluetooth, and various other devices in the Industrial, Scientific, and Medical (ISM) band. In contrast, OWC technologies exhibit superior capabilities in meeting the specific requirements of IoT networks compared to existing wireless technologies. The inherent advantages of OWC systems position them as a robust solution for addressing the multifaceted demands of IoT applications.

Small-cell networks: A highly effective approach for enhancing area spectral efficiency involves reducing the cell size in instances where a limited number of users are served by each cell [49]. In the evolution of communication systems, the third-generation system exclusively featured microcellular networks to support cellular connectivity. The 4G system introduced small-cell and microcell deployments alongside macrocellular networks, while the upcoming 5G system is anticipated to

incorporate ultra-dense small-cells in addition to macro cellular networks [50]. The reduction in cell size presents an opportunity to allocate more spectra to each user. The integration of indoor small-cells or femtocells has significantly expanded possibilities in this regard. An indoor small-cell typically has a cell radius of around 10 meters, catering to five to six users [51]. This deployment strategy proves cost-effective and energy-efficient, meeting coverage and capacity requirements [52]. With the anticipated peak user data rates reaching 10 Gbps for 5G and 1 Tbps for 6G communication systems, the management of heavy data traffic, particularly generated indoors, becomes crucial. Consequently, the deployment of highly dense small-cell networks emerges as a key characteristic of 5G communication systems. Indoor VLC and LiFi technologies contribute to the creation of highly dense small cells. Each network formed under a single light source is considered a small cell, and in large indoor spaces, hundreds of VLC/LiFi-based small cells can be established. Therefore, OWC networks align with the criteria essential for the development and success of 5G/6G networks.

Seamless movement: Seamless mobility is a pivotal requirement for the incorporation of any technology into the 5G networks. The LiFi system stands out by providing comprehensive support for mobility, addressing the demands of both 5G and anticipated 6G communication systems. High-capacity backhaul networks play a crucial role in connecting the access network to the core network. Presently, backhaul networks predominantly utilize dedicated fiber, copper, microwave, mm Wave, and occasionally satellite links [8,53]. Satellite links for backhaul connectivity are contingent on alternative options. In the context of 5G systems, a high-capacity backhaul network is indispensable for facilitating the exchange of substantial data traffic between the access and core networks. Without a robust high-capacity backhaul network, even if the access networks support Gbps communication links to user equipment, the communication system remains incomplete, with a low-capacity backhaul network posing a potential bottleneck. To address this challenge, optical wireless networks, such as FSO systems, alongside wired optical fiber networks, present effective solutions. FSO systems exhibit remarkable features for establishing high-capacity, long-range outdoor backhaul links. Figure 7 illustrates Establishment of high-capacity backhaul connectivity for a ship connectivity, space communications, cellular BS & remote connectivity. FSO technology can also establish high-quality connectivity with Macrocellular Base Stations (MBSs), offering an alternative to existing backhaul network technologies. A comparative analysis in Table 3 highlights the achieved data rates and latencies of key backhaul technologies. While optical fiber currently boasts the highest throughput, FSO systems

demonstrate comparable throughput. Given their similar transmitter and receiver architecture, FSO systems have the potential to achieve throughput levels similar to optical fiber systems in the near future. Latency, calculated for transmission during backhaul connectivity, underscores the FSO network's potential as a valuable complementary solution to wired, microwave, and mmWave systems, supporting high-data-rate communications in 5G and 6G networks.

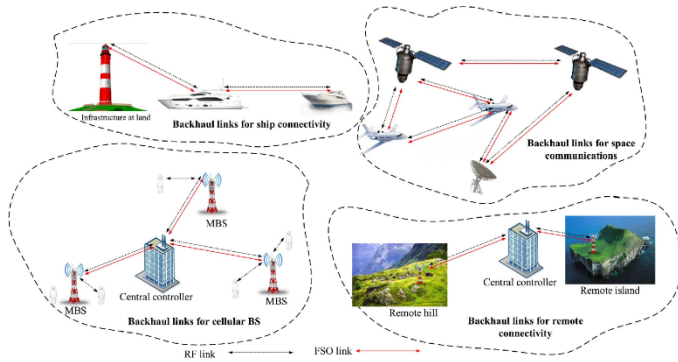

Figure 7: Establishing high-capacity backhaul connectivity for a ship connectivity, space communications, cellular BS & remote connectivity.

Table 4: Comparison of the achieved data rates and latencies in the existing important backhaul technologies [2,9,54]

Backhaul Technology	Achieved Data Rates	Latency
Optical Fiber	Highest throughput	Low
Copper	Moderate	Moderate
Microwave	Moderate	Moderate
mm Wave	Moderate	Moderate
Satellite	Varies	High

Green Communication: The realization of green communication in future 5G/6G and IoT networks relies on various factors, including energy-conscious network deployment, the selection of communication devices, and the design of communication network protocols. Achieving environmental sustainability necessitates energy-efficient communication methods, a goal that can be effectively met through the increased utilization of LED-based OWC technologies. OWC technologies are poised to handle a substantial portion of the overall wireless data volume, leading to significant energy savings when employed for indoor communication. By leveraging LEDs, which serve dual purposes as both communication devices and illumination sources, OWC networks have the potential to contribute significantly to energy efficiency. Furthermore, OWC systems can play a role in energy harvesting (EH), as demonstrated by integrating solar cells into VLC links. This integration allows solar cells to function not only as energy harvesters but also as optical receivers [55]. Consequently, OWC systems play a pivotal role in establishing environmentally conscious communication systems, a

key characteristic integral to the development of 5G/6G and IoT networks.

Tactile internet support: The International Telecommunication Union characterizes the Tactile Internet as the forthcoming internet infrastructure merging ultra-low latency with exceptionally high levels of availability, reliability, and security. Representing the next phase of evolution for the IoT, the Tactile Internet will extend its scope to include interactions between humans and machines, as well as machine-to-machine interactions [56–59]. OWC technologies possess the capability to underpin the Tactile Internet. In a prior study [60], we introduced Human Bond Communication (HBC) as a concept facilitating continuous bidirectional communication among multiple users.

Intelligent transportation: Vehicular communication stands as a pivotal component of the modern era, promising pervasive connectivity with ultra-reliable and low-latency features [61]. V2X communications play a vital role in enhancing road safety, optimizing traffic efficiency, and ensuring the availability of infotainment services [62]. The Dedicated Short-Range Communication (DSRC) technology, operating in the 5.9 GHz band, is extensively utilized for supporting V2X communications, particularly in applications focused on vehicular safety [63]. In addition to DSRC, millimeter-wave (mm Wave) bands have gained prominence in V2X communications due to their ability to deliver Gigabits per second data rates, surpassing the capabilities of DSRC [63]. Furthermore, OWC technologies emerge as a promising option for ensuring reliable connectivity in LOS conditions. Specifically, VLC and LiFi can facilitate short-distance inter-vehicle communications, while OCC extends support for communication over a distance of 60 meters [64]. FSO communication, utilizing laser-based technology, offers the potential for even longer-distance communication in vehicular scenarios.

4.4. Surveys of OWC-Based 5G/6G and IoT Systems

Numerous researchers globally are actively engaged in exploring OWC for the development of future communication networks. An innovative approach introduced in [60] focuses on HBC utilizing head-mounted displays (HMDs). This method employs the camera of an HMD as a receiver and incorporates an IR light source as a transmitter, demonstrating the feasibility of HMDs for communication purposes. This HBC system enables efficient communication between users or devices using their respective HMDs. In [65], researchers propose an optical V2V communication system based on LED transmitters and camera receivers. This technology has the potential to emerge as a significant development for the Internet of Vehicles, where the LED transmitter in one vehicle communicates various data to camera receivers in

other vehicles using an optical communication image sensor. The LiFi/WiFi-integrated architecture presented in [66] is designed to meet the requirements of the 5G system, showcasing a comprehensive integration of LiFi and WiFi. A universal traffic management system detailed in [67] provides expressway and road information to vehicles. This system utilizes LED headlights as transmitters for the uplink and multiple PDs with lenses as receivers on the roadside. For the downlink, signals are transmitted from an LED on a roadside unit and received using an optical communication image sensor on the vehicle. Motivating factors for VLC usage in supporting highly dense users are discussed in [68]. The study explores VLC integration with RF technologies, emphasizing the importance of selecting suitable operating conditions for optimal outcomes in both RF and VLC solutions. Additionally, [69] introduces a relay-assisted VLC system where an amplify-and-forward relay is employed to forward signals while simultaneously transmitting its own signals. The relay terminal assists the source terminal in forwarding signals to the destination terminal, with signal allocation to even and odd subcarriers for source and relay terminals, respectively.

The integration of 5G New Radio (NR) with VLC downlink architecture is elucidated by the authors in [70], showcasing the synergistic potential of these emerging wireless technologies. Specifically, the transmission of 5G NR frames over VLC is meticulously implemented, marking a significant stride in bridging these complementary technologies. Furthermore, in the context of a three-dimensional hybrid RF/VLC indoor IoT system described in [71], a homogeneous Poisson point process is employed to model terminal distribution. This study incorporates a light energy harvesting (EH) model alongside a LOS propagation model for VLC, enabling efficient energy utilization. Notably, the harvested energy from PDs at each device within the room is leveraged for transmissions over the RF uplink. The paper underscores pivotal advancements in OWC technologies, addressing future demands posed by 5G, 6G, and IoT systems, an aspect largely unexplored in existing review literature. By comprehensively examining various OWC technologies, the article delineates their potential contributions towards realizing the objectives of next-generation wireless systems.

5. Challenges of the OWC in the 5G/6G and IoT Solutions

Successfully deploying OWC technologies for 5G/6G and IoT solutions necessitates adeptly tackling a range of formidable challenges. Several critical challenges are succinctly examined below:

Frequent handover: Prospective communication systems will be characterized by heterogeneous small dense

networks, leading to frequent handovers. These handovers will occur both within optical networks and between optical and RF networks. Given the diminutive size of optical cells, the likelihood of numerous superfluous handovers exists, necessitating the mitigation of unnecessary handovers and the associated ping-pong effect. Additionally, the distinctive properties of the physical and data-link layers in optical and RF-based wireless networks pose a significant challenge for ensuring effective mobility support in RF/optical hybrid systems.

Inter-cell interference: Effectively addressing the management of inter-cell optical interference emerges as a critical concern during the deployment of optical VLC and LiFi networks. The dense deployment of LEDs in OWC technologies has the potential to induce substantial interference within 5G/6G and IoT networks. Consequently, the mitigation of inter-cell optical interference stands out as a formidable challenge in this context.

Atmospheric loss: The efficacy of OWC technologies is susceptible to various atmospheric factors such as scattering, refraction, air absorption, free space loss, and scintillation. Outdoor settings introduce additional challenges, as fog and dust impede the transmission of optical signals from the transmitter to the receiver. Unfavorable atmospheric conditions contribute to degradation in the communication link quality for FSO. Consequently, mitigating atmospheric losses poses a considerable challenge, particularly in outdoor environments, in striving to achieve the objectives of 5G networks.

Limited uplink communication using OWC technologies: Many user equipment designs incorporate low-power LEDs to minimize power consumption. However, this presents challenges for VLC and LiFi systems in uplink communication. The use of low-power LEDs results in diffused, low-intensity light, making them susceptible to interference from downlink high-power lights and thereby constraining uplink communication performance. Additionally, the vulnerability of the uplink communication link is heightened by the slightest deflection or movement of the user equipment's receiver. Addressing these issues is crucial for the future enhancement of VLC and LiFi systems to efficiently support uplink communication.

Low data rate of the OCC system: A significant limitation of the current OCC system is its constrained data rate, primarily attributed to the low-frame rate cameras employed. Achieving a high data rate is challenging within this framework, as evidenced by the most recent recorded data rate of only 55 Mbps [27]. There is a pressing need to augment this data rate to meet the

burgeoning service requirements in the context of 5G/6G and IoT networks.

Flickering avoidance: Flickering refers to variations in the luminance of light perceivable by humans, posing a significant concern in OWC systems. Various modulation schemes employed in OWC systems may induce flickering, which can adversely impact human health. Effectively addressing this challenge involves modulating LEDs in a manner that mitigates flickering, adding a layer of complexity to the task.

Data rate improvement of the FSO backhaul system: The backhaul infrastructure within 5G/6G systems is tasked with managing a substantial volume of data traffic to facilitate high-data-rate services for end-users. Failure to address this efficiently may lead to bottleneck issues. Consequently, the challenging endeavor involves enhancing FSO backhaul capacity in response to the escalating traffic volumes.

Machine learning for OWC: The future landscape of 6G communication networks necessitates the incorporation of learning-based networking systems as a key requirement. Given the escalating complexity of network structures and diverse requirements, artificial control and decision-making become imperative in challenging environments. Supervised learning finds application in various OWC-based scenarios such as smart healthcare [72], smart home lighting [73], and OWC data mining. Unsupervised machine learning methods prove efficient for OWC data-based analysis, encompassing tasks such as correlation, ranking, spatial and temporal analysis, and flow prediction. Furthermore, reinforcement learning emerges as a valuable tool for optimizing data rates, implementing network switching, and managing traffic within ultra-dense OWC networks designed for 6G [14]. The integration of machine learning into 6G OWC networks facilitates intelligent network assignment, automated error correction, efficient decision-making, and network reassignment, among other functionalities. Notably, the application of the machine learning approach is integral in the context of indoor mobile robot-based dense OWC small networks, enabling swift and efficient task execution.

6. Conclusion

The introduction of 5G communication is anticipated to occur by 2020, followed by the projected launch of 6G communication between 2027 and 2030. Realizing the objectives of 5G/6G and the IoT through the tactile internet poses several challenges. Key among these challenges are the provision of high capacity, massive connectivity, low latency, high security, low-energy consumption, high QoE, and highly reliable connectivity for 5G communication systems. Solely relying on RF-

based systems proves insufficient to meet the substantial demands of future 5G/6G and IoT networks. OWC technologies, including VLC, LiFi, OCC, and FSO communication, emerge as ideal complementary solutions to RF networks. The concurrent operation of RF and optical wireless systems holds the potential to achieve the ambitious goals set for these networks. This study provides a comprehensive examination of how OWC technologies contribute to the successful deployment of future 5G/6G and IoT networks. The characteristics of 5G, 6G, and IoT systems, as well as the features of OWC technologies such as VLC, LiFi, OCC, and FSO, are succinctly outlined. Each specification of 5G, 6G, and IoT is individually expounded upon, highlighting how OWC systems facilitate the realization of these features. Additionally, the paper offers a summary of existing OWC-related studies pertaining to 5G and IoT, making it a valuable resource for comprehending research contributions across various optical wireless systems in the context of future network deployment.

Conflict of Interest

The authors declare no conflict of interest.

References

- [1] Z. Ghassemlooy, S. Arnon, M. Uysal, Z. Xu, J. Cheng, "Emerging optical wireless communications—advances and challenges," *IEEE Journal on Selected Areas in Communications*, vol. 33, no. 9, 1738–1749, 2015, doi:10.1109/JSAC.2015.2430821.
- [2] M.Z. Chowdhury, M.T. Hossan, A. Islam, Y.M. Jang, "A comparative survey of optical wireless technologies: Architectures and applications," *IEEE Access*, vol. 6, 9819–10220, 2018, doi:10.1109/ACCESS.2018.2799852.
- [3] M. Uysal, H. Nouri, "Optical wireless communications—An emerging technology," in *Proceedings of the International Conference on Transparent Optical Networks*, 2014, doi:10.1109/ICTON.2014.6876505.
- [4] Z. Xu, R.B.M. Sadler, "Ultraviolet communications: Potential and state-of-the-art," *IEEE Communications Magazine*, vol. 46, no. 7, 67–73, 2008, doi:10.1109/MCOM.2008.4569743.
- [5] J.B. Carruthers, *Wireless Infrared Communications*, Wiley Encyclopedia of Telecommunications, 2003.
- [6] P.H. Pathak, X. Feng, P. Hu, P. Mohapatra, "Visible light communication, networking, and sensing: A survey, potential and challenges," *IEEE Communications Surveys & Tutorials*, vol. 17, no. 4, 2047–2077, 2015, doi:10.1109/COMST.2015.2444095.
- [7] M. Shafi, A.F. Molisch, P.J. Smith, T. Haustein, P. Zhu, P. De Silva, F. Tufvesson, A. Benjebbour, G. Wunder, "5G: A tutorial overview of standards, trials, challenges, deployment, and practice," *IEEE Journal on Selected Areas in Communications*, vol. 35, no. 6, 1201–1221, 2017, doi:10.1109/JSAC.2017.2695280.
- [8] M. Jaber, M.A. Imran, R. Tafazolli, A. Tukmanov, "5G backhaul challenges and emerging research directions: A survey," *IEEE*

- Access, vol. 4, 1143–1166, 2016, doi:10.1109/ACCESS.2016.2546541.
- [9] J.G. Andrews, S. Buzzi, W. Choi, S. V Hanly, A. Lozano, A.C. Soong, J.C. Zhang, “What will 5G be?” *IEEE Journal on Selected Areas in Communications*, vol. 32, no. 6, 1065–1082, 2014, doi:10.1109/JSAC.2014.2328098.
- [10] W.A. Hassan, H.-S. Jo, T.A. Rahman, “The feasibility of coexistence between 5G and existing services in the IMT-2020 candidate bands in Malaysia,” *IEEE Access*, vol. 5, 14867–14888, 2017, doi:10.1109/ACCESS.2017.2710159.
- [11] A. Ijaz, L. Zhang, M. Grau, A. Mohamed, S. Vural, A.U. Quddus, M.A. Imran, C.H. Foh, R. Tafazolli, “Enabling massive IoT in 5G and beyond systems: PHY radio frame design considerations,” *IEEE Access*, vol. 4, 3322–3339, 2016, doi:10.1109/ACCESS.2016.2546541.
- [12] K. David, H. Berndt, “6G vision and requirements: Is there any need for beyond 5G?” *IEEE Vehicular Technology Magazine*, vol. 13, no. 3, 72–80, 2018, doi:10.1109/MVT.2018.2816618.
- [13] F. Tariq, M. Khandaker, K.K. Wong, M. Imran, M. Bennis, M. Debbah, “A speculative study on 6G,” *ArXiv Preprint*, 2019.
- [14] S.J. Nawaz, S.K. Sharma, S. Wyne, M.N. Patwary, M. Asaduzzaman, “Quantum machine learning for 6G communication networks: State-of-the-art and vision for the future,” *IEEE Access*, vol. 7, 46317–46350, 2019, doi:10.1109/ACCESS.2019.2900597.
- [15] R.A. Stoica, G.T.F. Abreu, “6G: The wireless communications network for collaborative and AI applications,” *ArXiv Preprint ArXiv:1904.03413*, 2019.
- [16] W. Saad, M. Bennis, M. Chen, “A vision of 6G wireless systems: Applications, trends, technologies, and open research problems,” *ArXiv Preprint ArXiv:1902.10265*, 2019.
- [17] T. Nguyen, M.Z. Chowdhury, Y.M. Jang, “A novel link switching scheme using pre-scanning and RSS prediction in visible light communication networks,” *EURASIP Journal on Wireless Communications and Networking*, vol. 2013, 1–17, 2013, doi:10.1186/1687-1499-2013-1.
- [18] D. Tsonev, S. Videv, H. Haas, “Towards a 100 Gb/s visible light wireless access network,” *Optics Express*, vol. 23, no. 2, 1627–1637, 2015, doi:10.1364/OE.23.001627.
- [19] M.Z. Chowdhury, M.T. Hossan, M.K. Hasan, Y.M. Jang, “Integrated RF/optical wireless networks for improving QoS in indoor and transportation applications,” *Wireless Personal Communications*, vol. 107, no. 3, 1401–1430, 2018, doi:10.1007/s11277-018-5482-8.
- [20] H. Haas, L. Yin, Y. Wang, C. Chen, “What is LiFi?” *Journal of Lightwave Technology*, vol. 34, no. 6, 1533–1544, 2016, doi:10.1109/JLT.2016.2525829.
- [21] S. Dimitrov, H. Haas, *Principles of LED Light Communications: Towards Networked Li-Fi*, Cambridge University Press, 2015.
- [22] H.H. Lu, C.Y. Li, H.W. Chen, C.M. Ho, M.T. Cheng, Z.Y. Yang, C.K. Lu, “A 56 Gb/s PAM4 VCSEL-based LiFi transmission with two-stage injection-locked technique,” *IEEE Photonics Journal*, vol. 9, 1–8, 2017, doi:10.1109/JPHOT.2017.2696500.
- [23] M.K. Hasan, M.Z. Chowdhury, M. Shahjalal, Y.M. Jang, “Fuzzy based network assignment and link-switching analysis in hybrid OCC/LiFi system,” *Wireless Communications and Mobile Computing*, 2018, doi:10.1155/2018/5703580.
- [24] M. Hossan, M.Z. Chowdhury, M. Hasan, M. Shahjalal, T. Nguyen, N.T. Le, Y.M. Jang, “A new vehicle localization scheme based on combined optical camera communication and photogrammetry,” *Mobile Information Systems*, 2018, doi:10.1155/2018/4609192.
- [25] M. Shahjalal, M. Hossan, M. Hasan, M.Z. Chowdhury, N.T. Le, Y.M. Jang, “An implementation approach and performance analysis of image sensor based multilateral indoor localization and navigation system,” *Wireless Communications and Mobile Computing*, vol. 2018, 2018, doi:10.1155/2018/5703580.
- [26] Z. Ghassemlooy, P. Luo, S. Zvanovec, *Optical camera communications*, Springer: 547–568, 2016, doi:10.1007/978-3-319-48872-5_20.
- [27] Y. Goto, I. Takai, T. Yamazato, H. Okada, T. Fujii, S. Kawahito, S. Arai, T. Yendo, K. Kamakura, “A new automotive VLC system using optical communication image sensor,” *IEEE Photonics Journal*, vol. 8, 1–17, 2016, doi:10.1109/JPHOT.2016.2593718.
- [28] A. Malik, P. Singh, “Free space optics: Current applications and future challenges,” *International Journal of Optics*, vol. 2015, , 2015, doi:10.1155/2015/146591.
- [29] M.A. Khalighi, M. Uysal, “Survey on free space optical communication: A communication theory perspective,” *IEEE Communications Surveys & Tutorials*, vol. 16, 2231–2258, 2014, doi:10.1109/SURV.2014.012214.00189.
- [30] H. Kaushal, G. Kaddoum, “Optical communication in space: Challenges and mitigation techniques,” *IEEE Communications Surveys & Tutorials*, vol. 19, 57–97, 2017, doi:10.1109/COMST.2016.2618498.
- [31] S. Mumtaz, J.M. Jornet, J. Aulin, W.H. Gerstacker, X. Dong, B. Ai, “Terahertz communication for vehicular networks,” *IEEE Transactions on Vehicular Technology*, vol. 66, 5617–5625, 2017, doi:10.1109/TVT.2016.2639738.
- [32] L. Lovén, T. Leppänen, E. Peltonen, J. Partala, E. Harjula, P. Poromaa, M. Ylianttila, J. Riekkii, “Edge AI: A vision for distributed, edge-native artificial intelligence in future 6G networks,” in *Proceedings of the 6G Wireless Summit*, Levi, Finland, 2019.
- [33] F. Clazzer, A. Munari, G. Liva, F. Lazaro, C. Stefanovic, P. Popovski, “From 5G to 6G: Has the time for modern random access come?” *ArXiv Preprint ArXiv:1903.03063*, 2019.
- [34] M. Giordani, M. Polese, M. Mezzavilla, S. Rangan, M. Zorzi, “Towards 6G networks: Use cases and technologies,” *ArXiv Preprint ArXiv:1903.12216*, 2019.
- [35] 5G Requirements.
- [36] *Light Communications for Wireless Local Area Networking*.
- [37] D. Menaka, C.T. Sabitha Gauni, Manimegalai, K. Kalimuthu, “Vision of IoUT: advances and future trends in optical wireless communication,” *Journal of Optics*, vol. 50, 439–452, 2021.
- [38] P. Hu, P.H. Pathak, A.K. Das, Z. Yang, P. Mohapatra, “PLiFi: Hybrid WiFi-VLC networking using power lines,” in *Proceedings of the Workshop on Visible Light Communication Systems*, New York, NY, USA, 2016.
- [39] Z. Du, C. Wang, Y. Sun, G. Wu, “Context-aware indoor VLC/RF heterogeneous network selection: Reinforcement learning with knowledge transfer,” *IEEE Access*, vol. 6, 33275–33284, 2018, doi:10.1109/ACCESS.2018.2847723.
- [40] T. Koonen, “Indoor optical wireless systems: Technology, trends, and applications,” *Journal of Lightwave Technology*, vol. 36, no. 7, 1459–1467, 2018, doi:10.1109/JLT.2018.2791740.

- [41] C. Danakis, M. Afgani, G. Povey, I. Underwood, H. Haas, "Using a CMOS camera sensor for visible light communication," in Proceedings of the IEEE Globecom Workshops, Anaheim, CA, USA, 2012.
- [42] H.M. Tsai, H.M. Lin, H.Y. Lee, "Demo: Rollinglight-universal camera communications for single LED," in Proceedings of the International Conference on Mobile Computing and Networking, Maui, HI, USA, 2014.
- [43] L.Y. Wei, C.W. Chow, G.H. Chen, Y. Liu, C.H. Yeh, C.W. Hsu, "Tricolor visible-light laser diodes based visible light communication operated at 40.665 Gbit/s and 2 m free-space transmission," *Optics Express*, vol. 27, no. 18, 25072–25077, 2019, doi:10.1364/OE.27.025072.
- [44] M.Z. Chowdhury, M. Shahjalal, M.K. Hasan, Y.M. Jang, "The Role of Optical Wireless Communication Technologies in 5G/6G and IoT Solutions: Prospects, Directions, and Challenges," *Applied Sciences*, vol. 9, 2019.
- [45] C. Chang, "A 100-Gb/s multiple-input multiple-output visible laser light communication system," *Journal of Lightwave Technology*, vol. 32, no. 22, 4723–4729, 2014, doi:10.1109/JLT.2014.2361215.
- [46] D. Zhang, Z. Zhou, S. Mumtaz, J. Rodriguez, T. Sato, "One integrated energy efficiency proposal for 5G IoT communications," *IEEE Internet of Things Journal*, vol. 3, 1346–1354, 2016, doi:10.1109/JIOT.2016.2593778.
- [47] Z. Yan, O. Zhang, A. V Vasilakos, "A survey on trust management for internet of things," *Journal of Network and Computer Applications*, vol. 42, 120–134, 2014, doi:10.1016/j.jnca.2014.01.012.
- [48] M.R. Palattella, M. Dohler, A. Grieco, G. Rizzo, J. Torsner, T. Engel, L. Ladid, "Internet of things in the 5G era: Enablers, architecture, and business models," *IEEE Journal on Selected Areas in Communications*, vol. 34, no. 3, 510–527, 2016, doi:10.1109/JSAC.2016.2525478.
- [49] X. Ge, J. Yang, H. Gharavi, Y. Sun, "Energy efficiency challenges of 5G small cell networks," *IEEE Communications Magazine*, vol. 55, no. 1, 184–191, 2017, doi:10.1109/MCOM.2017.1600493.
- [50] Y. Hao, M. Chen, L. Hu, J. Song, M. Volk, I. Humar, "Wireless fractal ultra-dense cellular networks," *Sensors*, vol. 17, no. 4, 841, 2017, doi:10.3390/s17040841.
- [51] M.Z. Chowdhury, Y.M. Jang, Z.J. Haas, "Cost-effective frequency planning for capacity enhancement of femtocellular networks," *Wireless Personal Communications*, vol. 60, no. 1, 83–104, 2011, doi:10.1007/s11277-010-9987-2.
- [52] H.A.U. Mustafa, M.A. Imran, M.Z. Shakir, A. Imran, R. Tafazolli, "Separation framework: An enabler for cooperative and D2D communication for future 5G networks," *IEEE Communications Surveys & Tutorials*, vol. 18, 419–445, 2016, doi:10.1109/ACCESS.2018.2847723.
- [53] X. Artiga, A. Perez-Neira, J. Baranda, E. Lagunas, S. Chatzinotas, R. Zetik, P. Gorski, K. Ntougias, D. Perez, G. Ziaragkas, "Shared access satellite-terrestrial reconfigurable backhaul network enabled by smart antennas at mmWave band," *IEEE Network*, vol. 32, no. 5, 46–53, 2018, doi:10.1109/MNET.2018.1700241.
- [54] F. Knobloch, "Delay analysis for optical wireless multihop networks," in Proceedings of the International Conference on Transparent Optical Networks (ICTON), Trento, Italy, 2016.
- [55] S. Zhang, D. Tsonev, S. Videv, S. Ghosh, G.A. Turnbull, I.D.W. Samuel, H. Haas, "Organic solar cells as high-speed data detectors for visible light communication," *Optica*, vol. 2, no. 7, 607–610, 2015, doi:10.1364/OPTICA.2.000607.
- [56] What is The Tactile Internet? Available online: <https://5g.co.uk/guides/what-is-the-tactile-internet> (accessed on 15 August 2019).
- [57] G. Fettweis, "The tactile internet: Applications and challenges," *IEEE Vehicular Technology Magazine*, vol. 9, no. 1, 64–70, 2014, doi:10.1109/MVT.2013.2293016.
- [58] A. Aijaz, M. Dohler, A.H. Aghvami, V. Friderikos, M. Frodigh, "Realizing the tactile internet: Haptic communications over next generation 5G cellular networks," *IEEE Wireless Communications*, vol. 24, no. 1, 82–89, 2017, doi:10.1109/MWC.2017.1600493.
- [59] M. Simsek, A. Aijaz, M. Dohler, J. Sachs, G. Fettweis, "5G-enabled tactile internet," *IEEE Journal on Selected Areas in Communications*, vol. 34, no. 3, 460–473, 2016, doi:10.1109/JSAC.2016.2525478.
- [60] M.T. Hossan, M.Z. Chowdhury, M. Shahjalal, Y.M. Jang, "Human bond communication with head-mounted displays: Scope, challenges, solutions, and applications," *IEEE Communications Magazine*, vol. 57, no. 2, 26–32, 2019, doi:10.1109/MCOM.2019.1800421.
- [61] S.A.A. Shah, E. Ahmed, M. Imran, S. Zeadally, "5G for vehicular communications," *IEEE Communications Magazine*, vol. 56, no. 11, 111–117, 2018, doi:10.1109/MCOM.2018.1700241.
- [62] S. Chen, J. Hu, Y. Shi, Y. Peng, J. Fang, R. Zhao, L. Zhao, "Vehicle-to-everything (V2X) services supported by LTE-based systems and 5G," *IEEE Communications Standards Magazine*, vol. 1, no. 1, 70–76, 2017, doi:10.1109/MCOMSTD.2017.1700015.
- [63] T.S. Rappaport, Y. Xing, G.R. MacCartney, A.F. Molisch, E. Mellios, J. Zhang, "Overview of millimeter wave communications for fifth generation (5G) wireless networks— with a focus on propagation models," *IEEE Transactions on Antennas and Propagation*, vol. 65, no. 12, 6213–6230, 2017, doi:10.1109/TAP.2017.2734243.
- [64] P. Luo, M. Zhang, Z. Ghassemlooy, H. Le Minh, H.M. Tsai, X. Tang, L.C. Png, D. Han, "Experimental demonstration of RGB LED-based optical camera communications," *IEEE Photonics Journal*, vol. 7, –12, 2015, doi:10.1109/JPHOT.2015.2457321.
- [65] I. Takai, T. Harada, M. Andoh, K. Yasutomi, K. Kagawa, S. Kawahito, "Optical vehicle-to-vehicle communication system using LED transmitter and camera receiver," *IEEE Photonics Journal*, vol. 6, 1–14, 2014, doi:10.1109/JPHOT.2014.2361215.
- [66] M. Ayyash, H. Elgala, A. Khreishah, V. Jungnickel, T. Little, S. Shao, M. Rahaim, D. Schulz, J. Hilt, R. Freund, "Coexistence of WiFi and LiFi toward 5G: Concepts, opportunities, and challenges," *IEEE Communications Magazine*, vol. 54, no. 2, 64–71, 2016, doi:10.1109/MCOM.2016.7432165.
- [67] T. Yamazato, N. Kawagita, H. Okada, T. Fujii, T. Yendo, S. Arai, K. Kamakura, "The uplink visible light communication beacon system for universal traffic management," *IEEE Access*, vol. 5, 22282–22290, 2017, doi:10.1109/ACCESS.2017.2766759.
- [68] M.B. Rahaim, T.D.C. Little, "Toward practical integration of dual-use VLC within 5G networks," *IEEE Wireless Communications*, vol. 22, 97–103, 2015, doi:10.1109/MWC.2015.7124872.
- [69] Z. Na, Y. Wang, M. Xiong, X. Liu, J. Xia, "Modeling and throughput analysis of an ADO-OFDM based relay-assisted

- VLC system for 5G networks," IEEE Access, vol. 6, 17586–17594, 2018, doi:10.1109/ACCESS.2018.2808258.
- [70] L. Shi, W. Li, X. Zhang, Y. Zhang, G. Chen, A. Vladimirescu, "Experimental 5G new radio integration with VLC," in Proceedings of the IEEE International Conference on Electronics, Circuits and Systems (ICECS), 1–4, 2018, doi:10.1109/ICECS.2018.8611640.
- [71] G. Pan, H. Lei, Z. Ding, Q. Ni, "3-D Hybrid VLC-RF indoor IoT systems with light energy harvesting," IEEE Transactions on Green Communications and Networking, vol. 3, 853–865, 2019, doi:10.1109/TGCN.2019.2908839.
- [72] M.K. Hasan, M. Shahjalal, M.Z. Chowdhury, Y.M. Jang, "Real-time healthcare data transmission for remote patient monitoring in patch-based hybrid OCC/BLE networks," Sensors, vol. 19, 1208, 2019, doi:10.3390/s19051208.
- [73] K.P. Pujapanda, "LiFi Integrated to power-lines for smart illumination cum communication," in Proceedings of the International Conference on Communication Systems and Network Technologies, 1–4, 2013.

Copyright: This article is an open access article distributed under the terms and conditions of the Creative Commons Attribution (CC BY-SA) license (<https://creativecommons.org/licenses/by-sa/4.0/>).



RAMSHA KHALID has done her bachelor's degree from Lahore College for Women University, Lahore in 2018. She has done her master's degree from University of Lahore, Lahore in 2022. Her area of interest includes Computer & Communication Networks,

Machine Learning, Artificial Intelligence, Cyber Security, Control Systems and Renewable Energy Systems. Recently she has published a conference paper in IEEE INMIC'23 held in University of Central Punjab, Lahore as a first author.



M. NAQI RAZA has done his bachelor's degree from University of Gujrat, Gujrat in 2018. Currently, he is doing his master's degree from University of Sialkot, Sialkot.

His area of interest includes Power Generation (Conventional and Renewable), Wind Power Generation and Utilization, Optimization of Wind Energy, Solar Energy, Solar Power Applications, Electric Vehicles (PHEVs).